

# PACKAGING MADE SIMPLE



## How the process works



ENQUIRY



ESTABLISH NEEDS



INDICATIVE QUOTE



CREATE SAMPLE (COSTS)



FIRM QUOTE



CAD DRAWINGS



PRODUCTION



DELIVERY

**MINIMUM ORDER QUANTITY** = 250 UNITS

**PAYMENT TERMS:** 50% WITH ORDER, 50% PRIOR TO DISPATCH

**PRE PRODUCTION SAMPLE CHARGE:** £35 +VAT

### INFORMATION

**WE WILL REQUIRE:** CARTON STYLE • QUANTITY • MATERIAL • WHAT WILL GO INSIDE THE PACKAGING

## Carton Styles

### Glued Sleeve

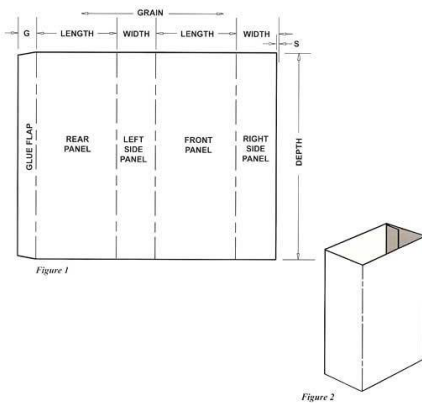

L: \_\_\_\_\_

W: \_\_\_\_\_

D: \_\_\_\_\_

### Sleeve with Locking Tabs

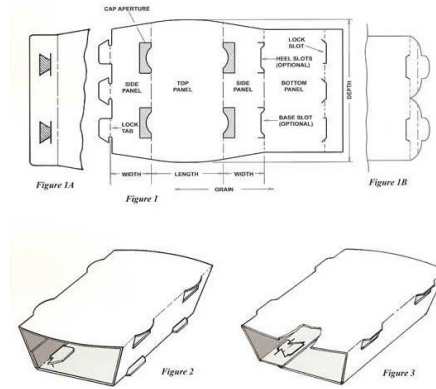

L: \_\_\_\_\_

W: \_\_\_\_\_

D: \_\_\_\_\_

### Side Glued Tuck in End

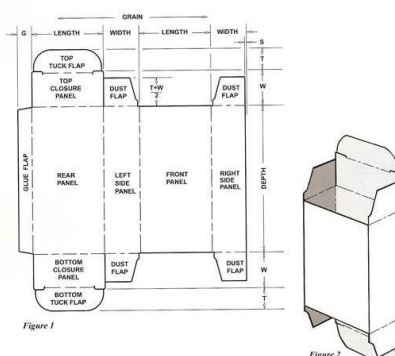
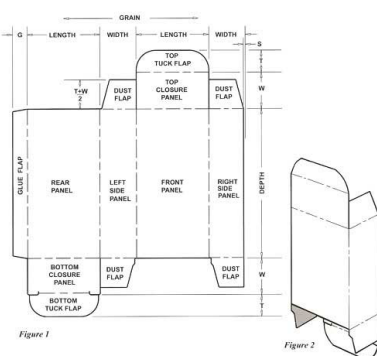

L: \_\_\_\_\_

W: \_\_\_\_\_

D: \_\_\_\_\_

## Crash Lock Base Carton

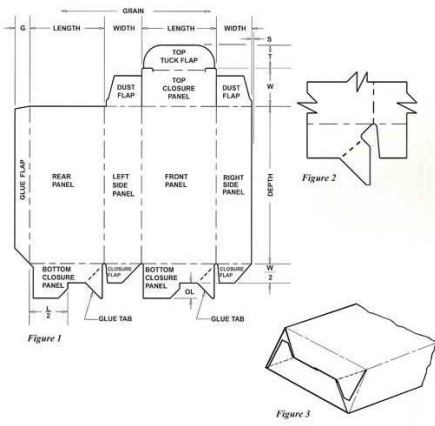

L: \_\_\_\_\_  
 W: \_\_\_\_\_  
 D: \_\_\_\_\_

## Hand Erect Lid & Base

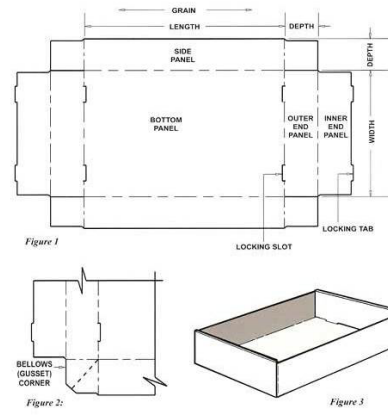

L: \_\_\_\_\_  
 W: \_\_\_\_\_  
 D: \_\_\_\_\_

## Envelope Base Carton

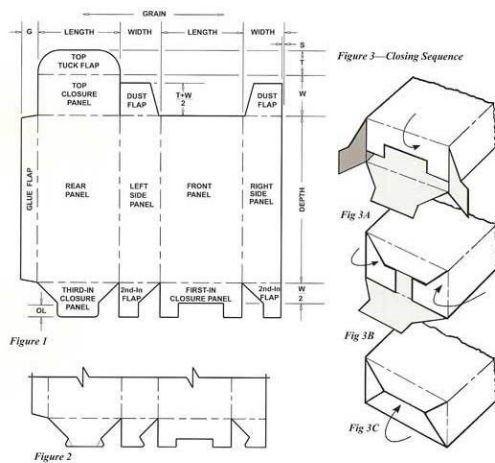

L: \_\_\_\_\_  
 W: \_\_\_\_\_  
 D: \_\_\_\_\_

## Pillow Pack

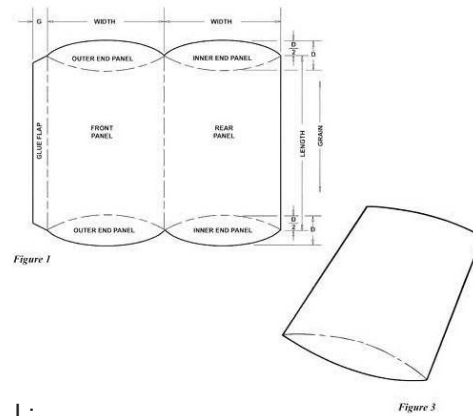

L: \_\_\_\_\_  
 W: \_\_\_\_\_  
 D: \_\_\_\_\_

## How to Measure your Carton

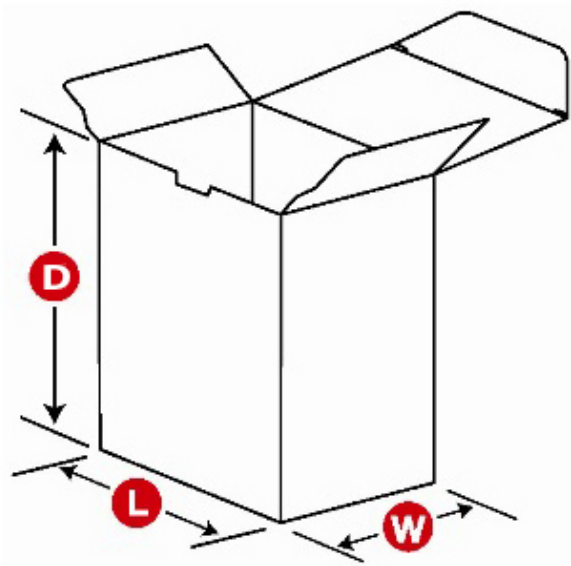

There are other styles of bespoke packaging. If you have an idea of what you require please get in touch.